

$V_{DSS}$ $T_j = 125^\circ\text{C}$	700V
$V_{DSS}$ $T_j = 25^\circ\text{C}$	650V
$R_{DS(on)}$ (Max.)	0.78 $\Omega$
$I_D$	7A
$P_D$	40W

### Outline

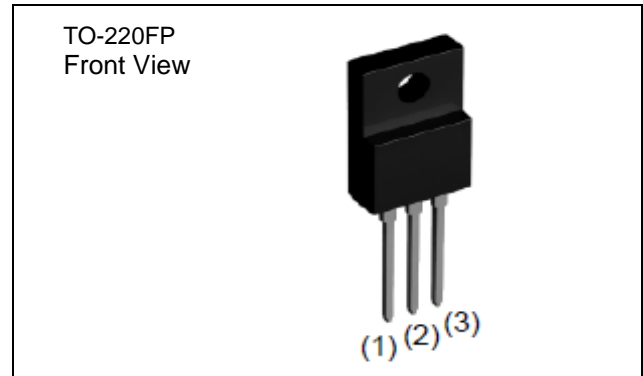

### FEATURES

- ◆ Low on-resistance
- ◆ Fast switching speed
- ◆ Gate-source voltage ( $V_{GS}$ ) guaranteed to be  $\pm 20\text{V}$
- ◆ Drive circuits can be simple
- ◆ Parallel use is easy
- ◆ Pb-free lead plating ; RoHs compliant

### Inner circuit

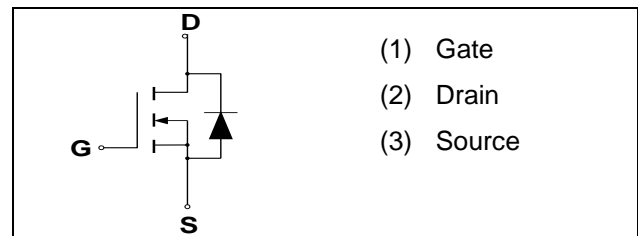

### Application

- ◆ Switching Power Supply

### Packaging specificationa

Type	Packaging	Bulk
	Reel size (mm)	-
	Tape width (mm)	-
	Basic ordering unit (pcs)	1,000
	Taping code	-
	Marking	CMS6507A

### ORDERING INFORMATION

Part Number	Temperature Range	Package
CMS6507AENX	$-55^\circ\text{C}$ to $150^\circ\text{C}$	TO-220FP

\*Note :

AE\*Series

N\*:N-ch Mosfet

X\*TO-220FP

### ABSOLUTE MAXIMUM RATINGS (Ta=25°C)

Parameter		Symbol	Value	Unit
Drain-Source Voltage		V <sub>DSS</sub>	650	V
Continuous drain current	Tc=25°C	I <sub>D</sub> <sup>*1</sup>	±7	A
	Tc=100°C	I <sub>D</sub> <sup>*1</sup>	±3.8	A
Pulsed drain current		I <sub>D, pulse</sub> <sup>*2</sup>	±14	A
Gate-Source Voltage		V <sub>GSS</sub>	±20	V
Avalanche energy, single pulse		E <sub>AS</sub> <sup>*3</sup>	133	mJ
Avalanche energy, repetitive		E <sub>AR</sub> <sup>*3</sup>	0.2	mJ
Avalanche current, repetitive		I <sub>AR</sub>	1.3	A
Power Dissipation (Tc=25°C)		P <sub>D</sub>	40	W
Junction temperature		T <sub>J</sub>	150	°C
Range of storage temperature		T <sub>stg</sub>	-55 to +150	°C
Reverse diode dv/dt		Dv/dt <sup>*4</sup>	15	V/ns
Drain-Source Voltage Slope	V <sub>DS</sub> =480V ; T <sub>j</sub> =25°C	Dv/dt	50	V/ns

### THERMAL RESISTANCE

Parameter	Symbol	Value			Unit
		Min.	Typ.	Max.	
Thermal resistance , junction-case	R <sub>thJC</sub>	-	-	3.13	°C/W
Thermal resistance , junction-ambient	R <sub>thJA</sub>	-	-	70	°C/W
Soldering temperature , wavesoldering for 10s	T <sub>sold</sub>	-	-	265	°C

### ELECTRICAL CHARACTERISTICS (Ta=25°C)

Parameter	Symbol	Conditions	Value			Unit
			Min.	Typ.	Max.	
Drain-Source breakdown voltage	V <sub>(BR)DSS</sub>	V <sub>GS</sub> = 0V, I <sub>D</sub> = 250uA	650	-	-	V
Zero gate voltage drain current	I <sub>DSS</sub>	V <sub>DS</sub> = 600V, V <sub>GS</sub> = 0V				uA
		T <sub>j</sub> = 25°C	-	0.1	100	
		T <sub>j</sub> = 125°C	-	-	1000	
Gate-Source leakage current	I <sub>GSS</sub>	V <sub>GS</sub> = ±20V, V <sub>DS</sub> = 0V	-	-	±100	nA
Gate threshold voltage	V <sub>GS(th)</sub>	V <sub>DS</sub> = 10V, I <sub>D</sub> = 1mA	2	-	4	V
Static drain-source on-state resistance	R <sub>DS(on)</sub> <sup>*5</sup>	V <sub>GS</sub> = 10V, I <sub>D</sub> = 2.4A				Ω
		T <sub>j</sub> = 25°C	-	0.6	0.78	
		T <sub>j</sub> = 125°C	-	1.20	-	
Gate input resistance	R <sub>G</sub>	F = 1MHz, open drain	-	10.6	-	Ω

### ELECTRICAL CHARACTERISTICS (Ta=25°C)

Parameter	Symbol	Conditions	Value			Unit
			Min.	Typ.	Max.	
Transconductance	$G_{fs}^{*5}$	$V_{DS} = 10V, I_D = 3.5A$	1.8	3.6	-	S
Input capacitance	$C_{iss}$	$V_{GS} = 0V$ $V_{DS} = 25V$ $F = 1MHz$	-	390	-	pF
Output capacitance	$C_{oss}$		-	390	-	
Reverse transfer capacitance	$C_{rss}$		-	50	-	
Effective output capacitance, energy related	$C_{o(er)}$	$V_{GS} = 0V$	-	21	-	pF
Effective output capacitance, time related	$C_{o(tr)}$	$V_{DS} = 0V \text{ to } 480V$	-	88	-	
Turn-on delay time	$T_{d(on)}^{*5}$	$V_{DD} \sim 300V, V_{GS} = 10V$ $I_D = 3.5A$ $R_L = 86.6\Omega$ $R_G = 10\Omega$	-	25	-	ns
Rise time	$T_r^{*5}$		-	25	-	
Turn-off delay time	$T_{d(off)}^{*5}$		-	70	-	
Fall time	$T_f^{*5}$		-	35	-	

### GATE CHARACTERISTICS (Ta=25°C)

Parameter	Symbol	Conditions	Value			Unit
			Min.	Typ.	Max.	
Gate plateau voltage	$V_{(plateau)}$	$V_{DD} \sim 300V, I_D = 7A$	-	6.2	-	V
Total gate charge	$Q_g^{*5}$	$V_{DD} \sim 300V$ $I_D = 7A$ $V_{GS} = 10V$	-	20	-	nC
Gate-Source charge	$Q_{gs}^{*5}$		-	3	-	
Gate Drain charge	$Q_{gd}^{*5}$		-	11	-	

\*1 : Limit only by maximum temperature allowed

\*2 :  $P_w \leq 10us$ , Duty cycle  $\leq 1\%$

\*3 :  $I_D = 1.3A, V_{DD} = 50V$

\*4 : Reference measurement circuits Fig.5-1

\*5 : Pulsed

### BODY DIODE ELECTRICAL CHARACTERISTICS (Source-Drain) (Ta=25°C)

Parameter	Symbol	Conditions	Value			Unit
			Min.	Typ.	Max.	
Inverse diode continuous, forward current	$I_s^{*1}$	$T_c=25^\circ\text{C}$	-	-	7	A
Inverse diode direct current, pulsed	$I_{sM}^{*2}$		-	-	14	A
Forward Voltage	$V_{SD}^{*5}$	$V_{GS} = 0V, I_s = 7A$	-	-	1.5	V
Reverse recovery time	$T_{rr}^{*5}$	$I_s = 7A$ $Di/dt = 100A/us$	-	340	-	ns
Reverse recovery charge	$Q_{rr}^{*5}$		-	2.8	-	uC
Peak reverse recovery current	$I_{rrm}^{*5}$		-	17	-	A

### TYPICAL TRANSIENT THERMAL CHARACTERISTICS

Symbol	Value	Unit
$R_{th1}$	0.385	K/W
$R_{th2}$	1.24	
$R_{th3}$	2.2	
$C_{th1}$	0.00128	Ws/K
$C_{th2}$	0.013	
$C_{th3}$	0.448	

### Application Circuit

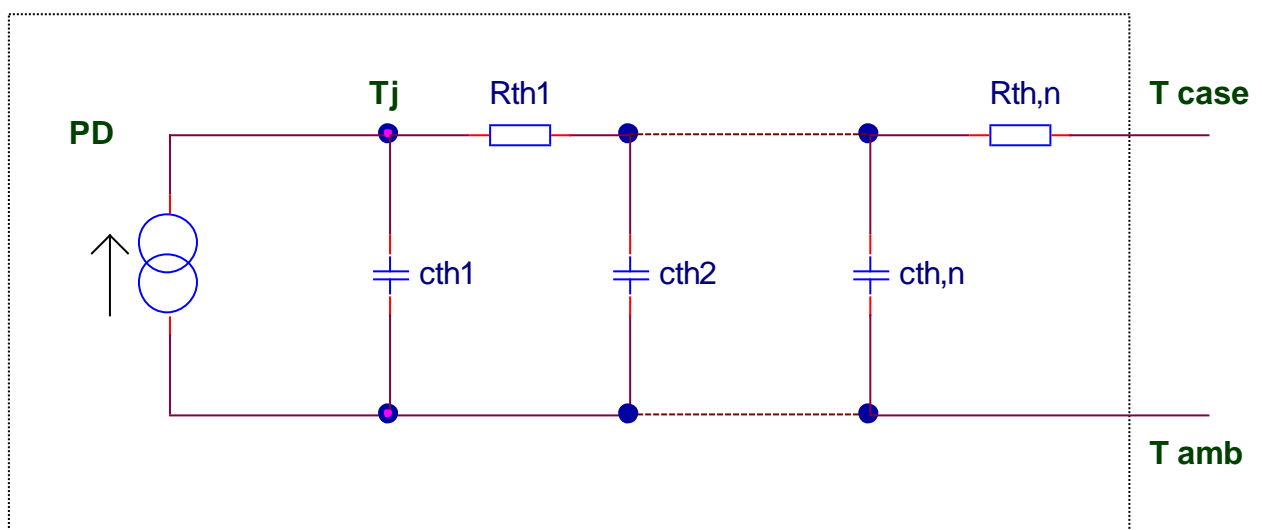

● Electrical characteristic curves

Fig.1 Power Dissipation Derating Curve

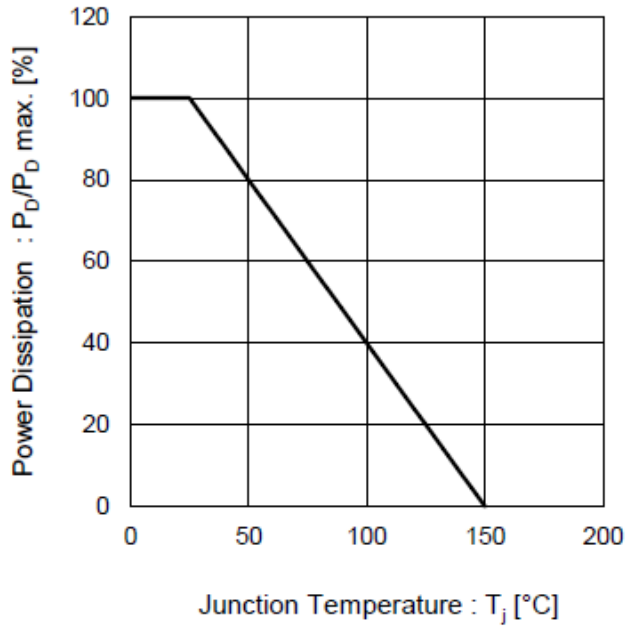

Fig.2 Normalized Transient Thermal Resistance vs. Pulse Width

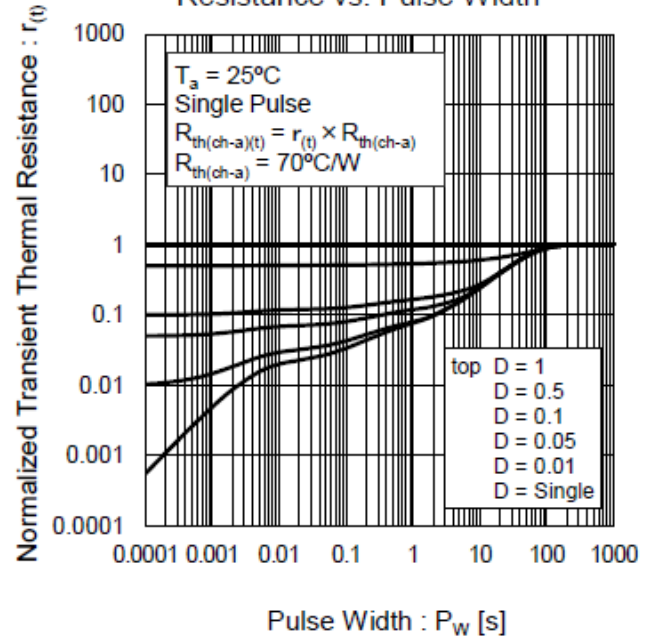
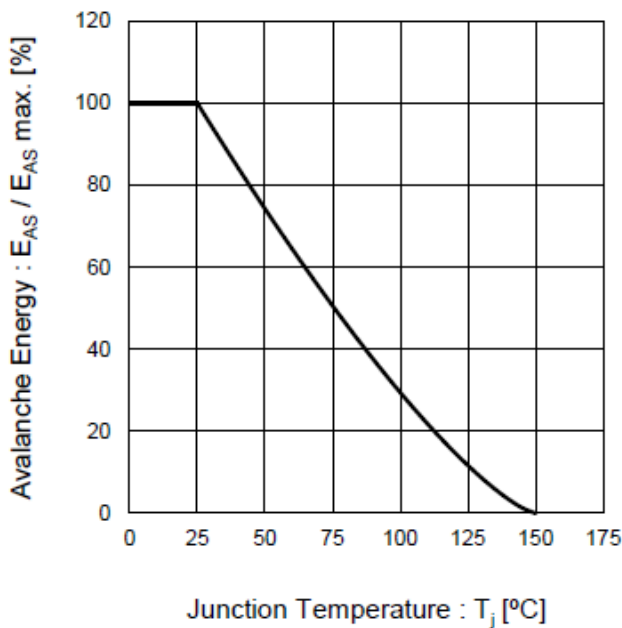

Fig.3 Avalanche Energy Derating Curve vs Junction Temperature



● Electrical characteristic curves

Fig.4 Typical Output Characteristics(I)

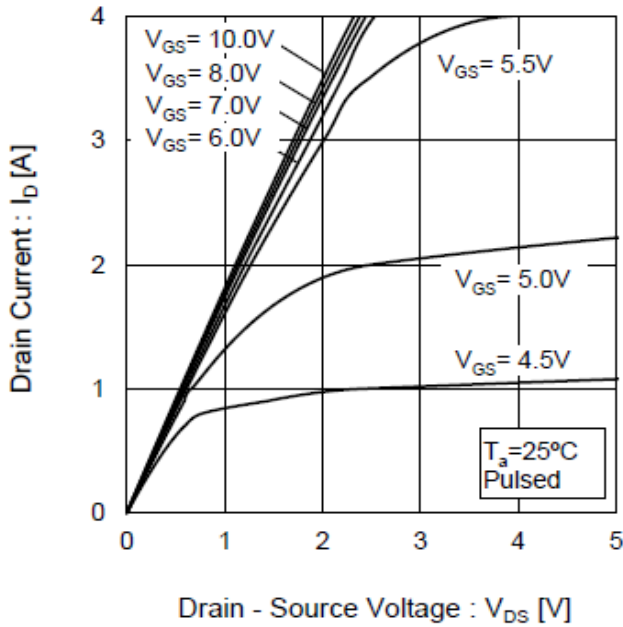

Fig.5 Typical Output Characteristics(II)

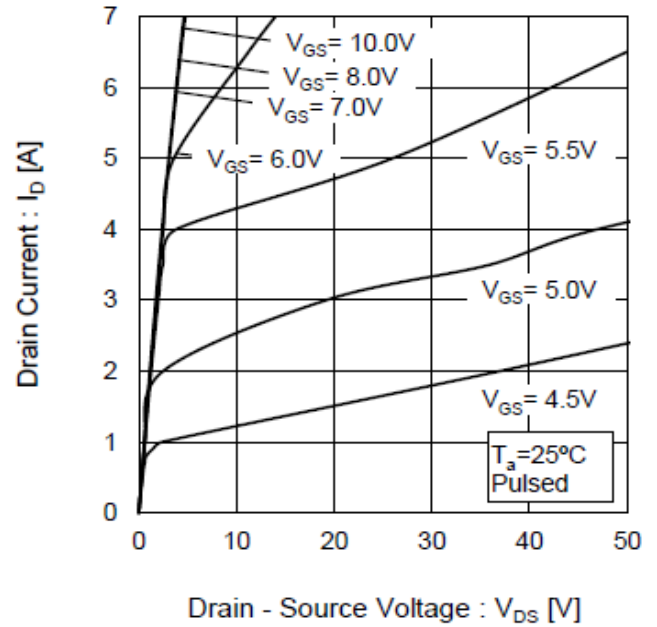

Fig.6  $T_j = 150^\circ\text{C}$  Typical Output Characteristics(I)

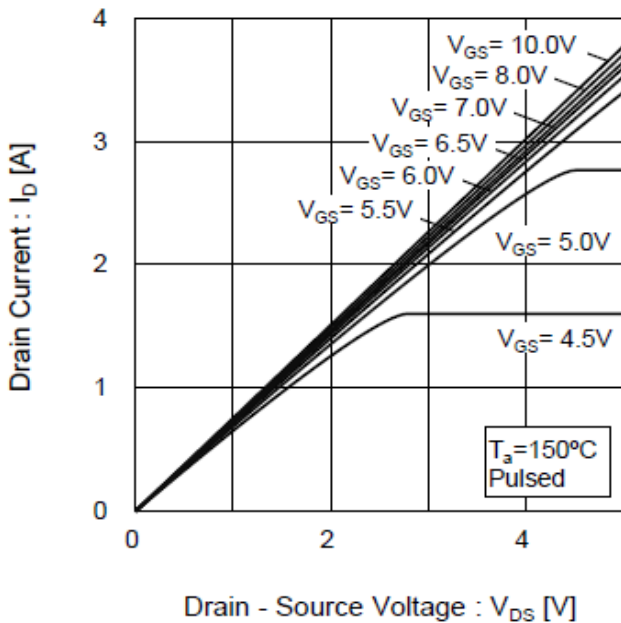
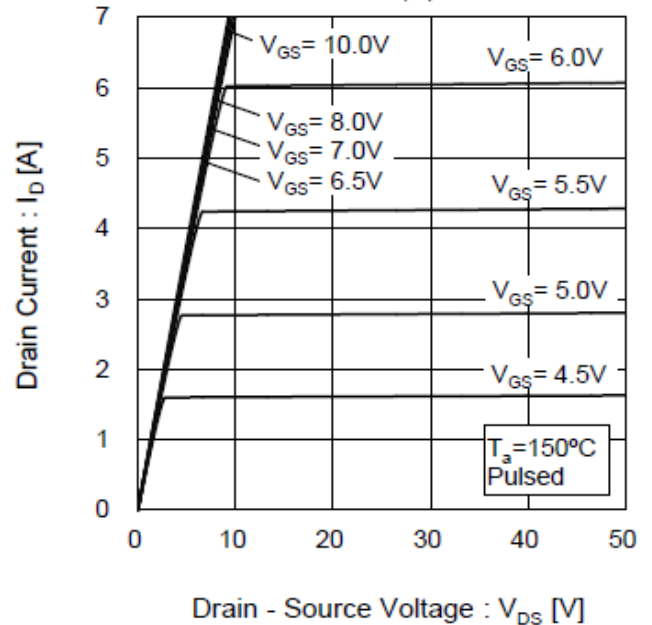

Fig.7  $T_j = 150^\circ\text{C}$  Typical Output Characteristics(II)



### ● Electrical characteristic curves

Fig.8 Breakdown Voltage vs. Junction Temperature

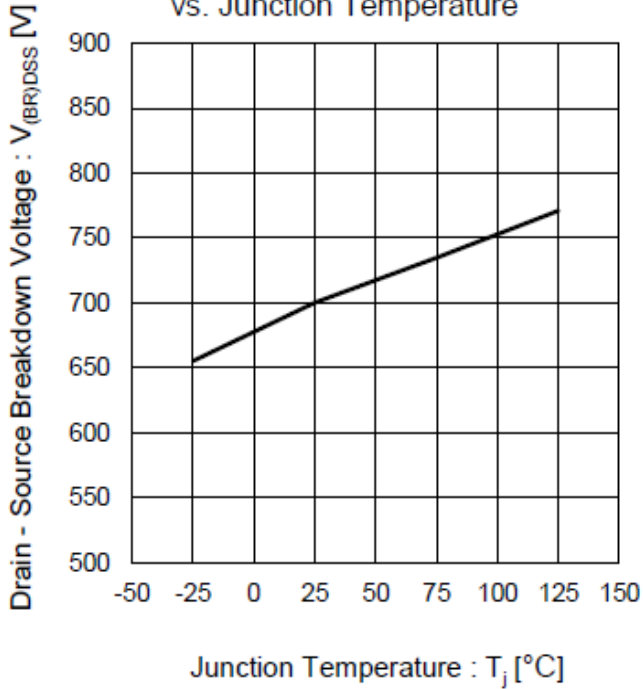

Fig.9 Typical Transfer Characteristics

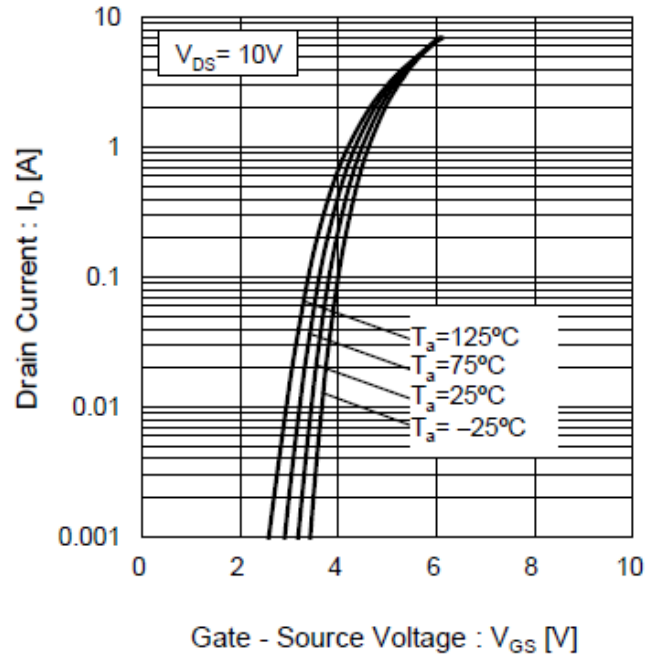

Fig.10 Gate Threshold Voltage vs. Junction Temperature

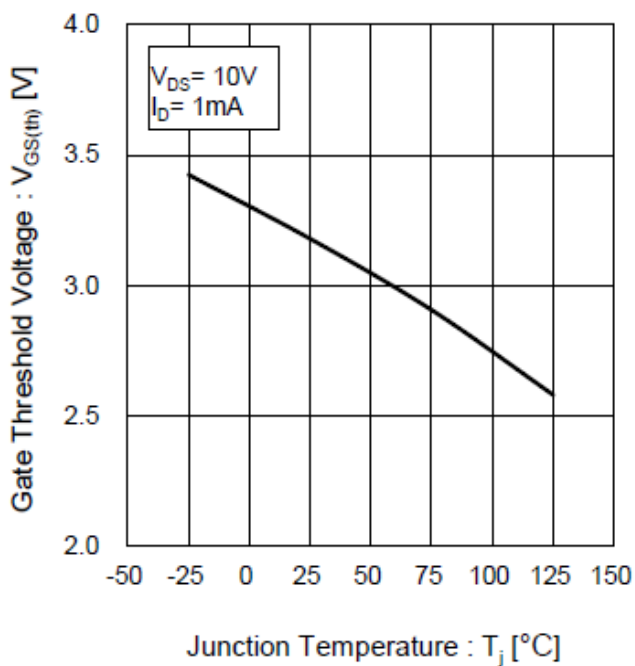
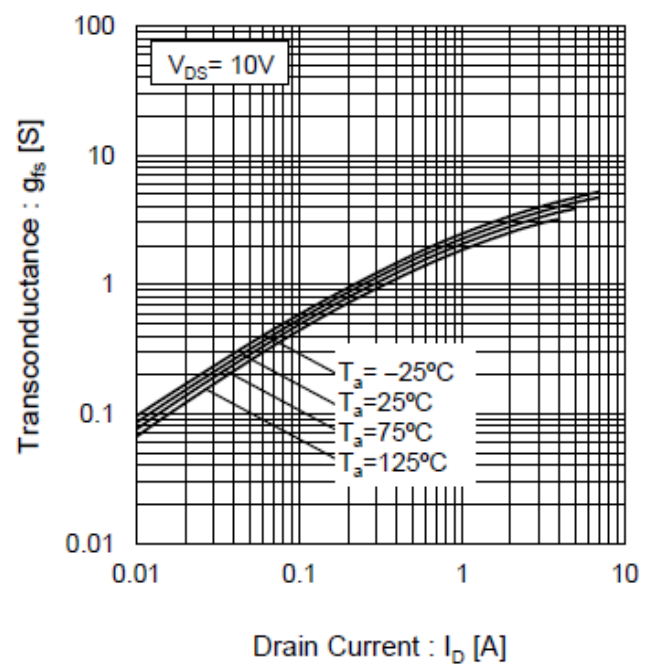

Fig.11 Transconductance vs. Drain Current



### ●Electrical characteristic curves

Fig.12 Static Drain - Source On - State Resistance vs. Gate Source Voltage

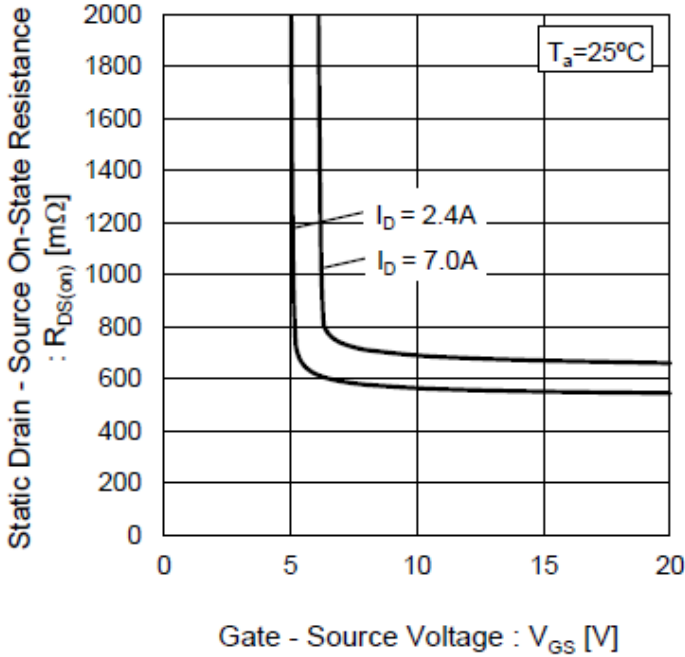

Fig.13 Static Drain - Source On - State Resistance vs. Junction Temperature

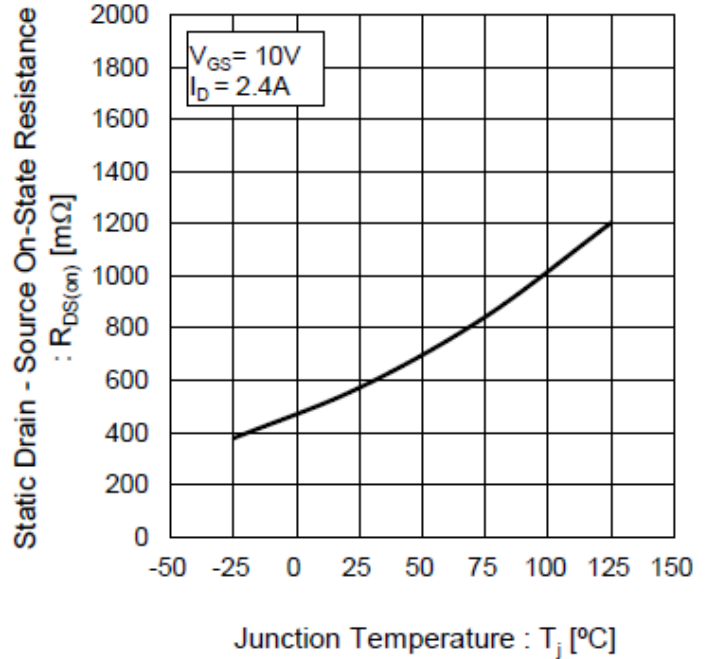

Fig.14 Static Drain - Source On - State Resistance vs. Drain Current

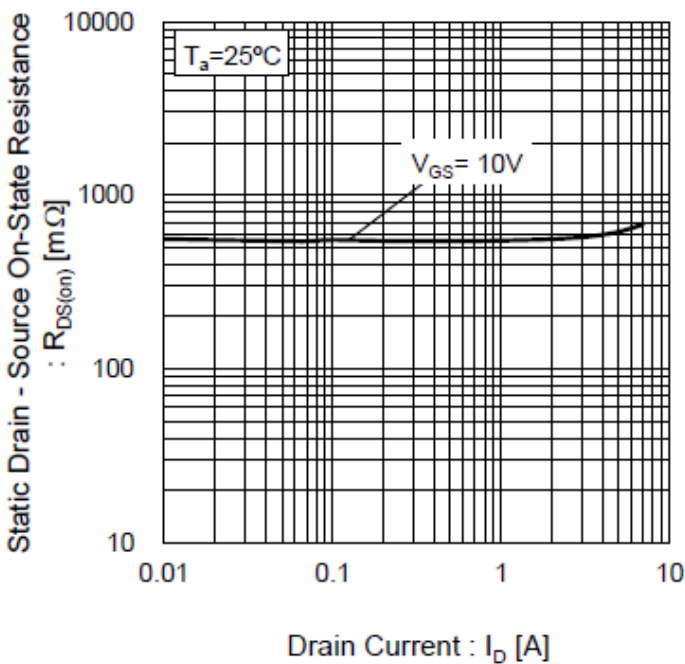
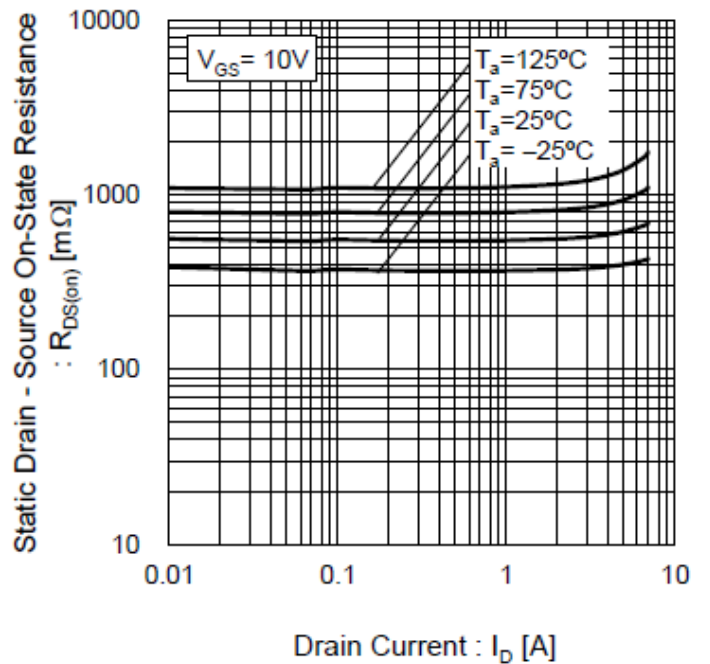

Fig.15 Static Drain - Source On - State Resistance vs. Drain Current





### ●Electrical characteristic curves

Fig.16 Typical Capacitance vs. Drain - Source Voltage

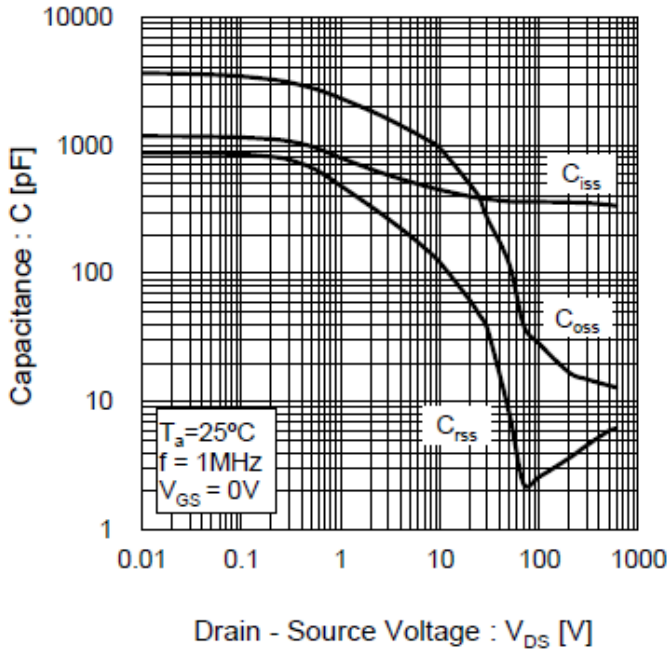

Fig.17 Coss Stored Energy

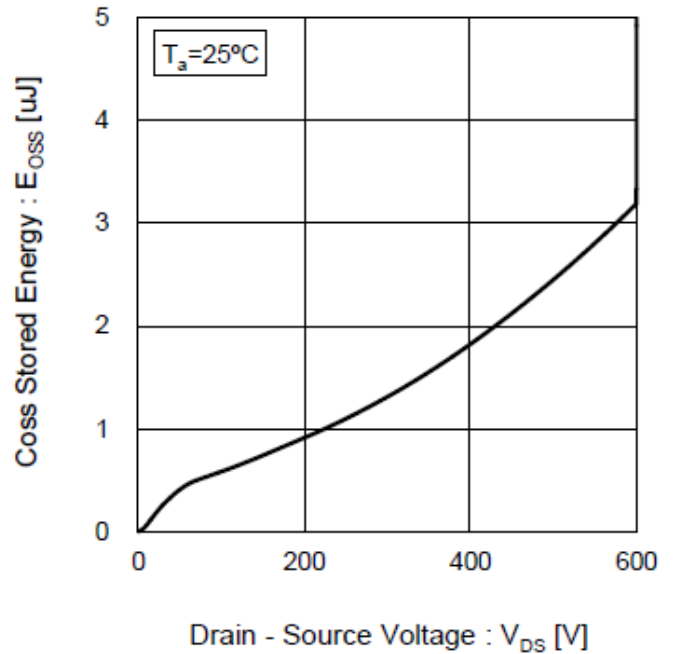

Fig.18 Switching Characteristics

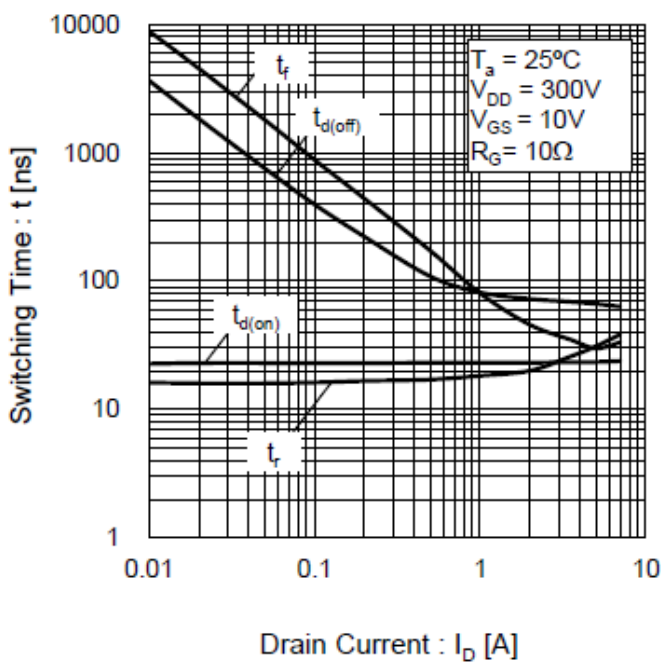
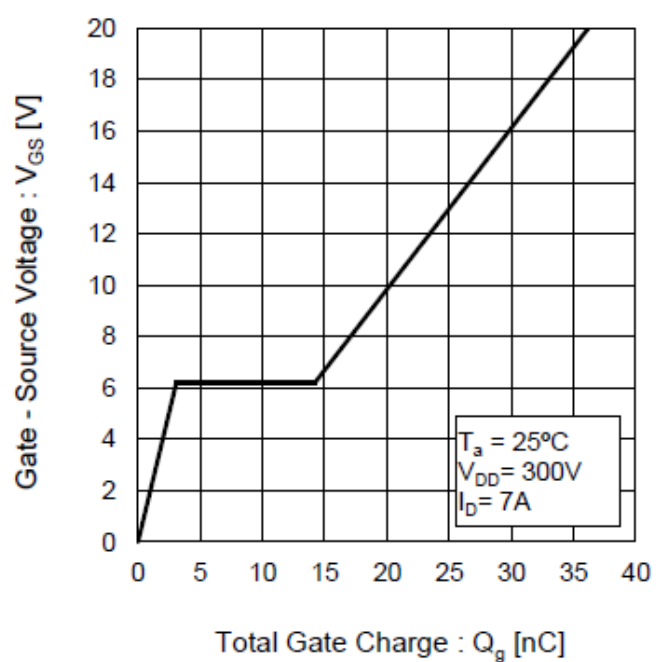

Fig.19 Dynamic Input Characteristics



●Electrical characteristic curves

Fig.20 Inverse Diode Forward Current vs. Source - Drain Voltage

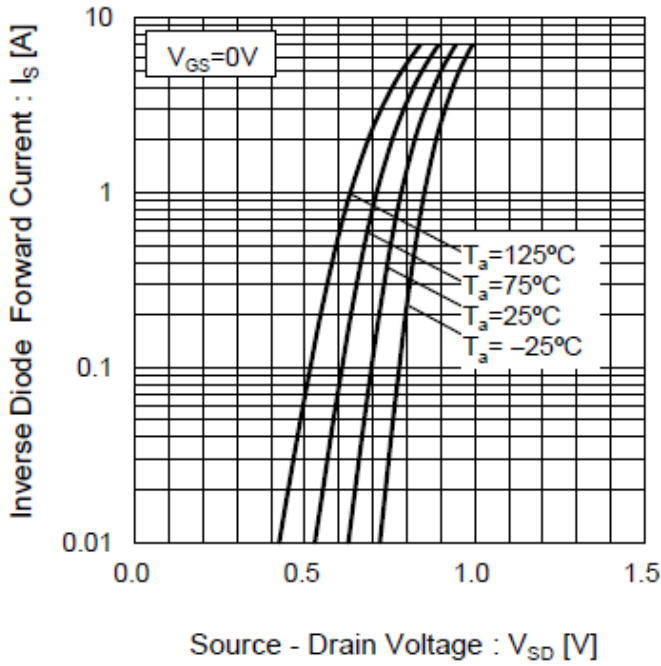
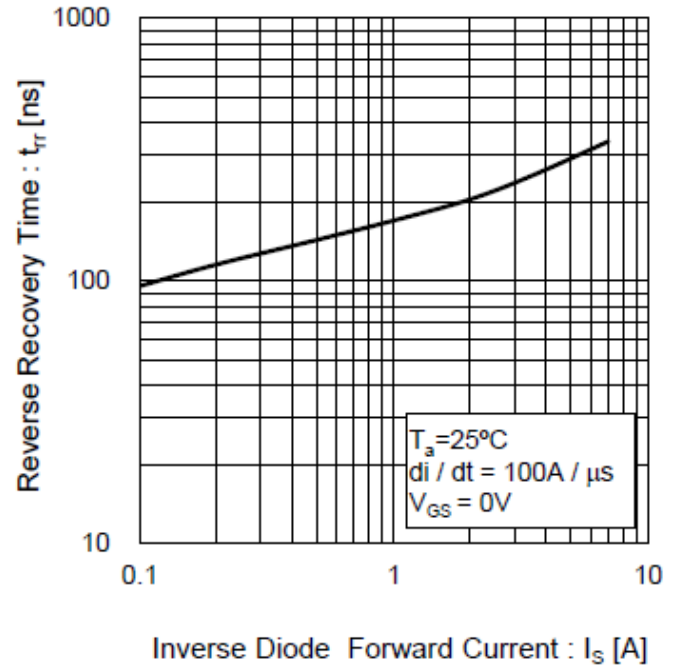
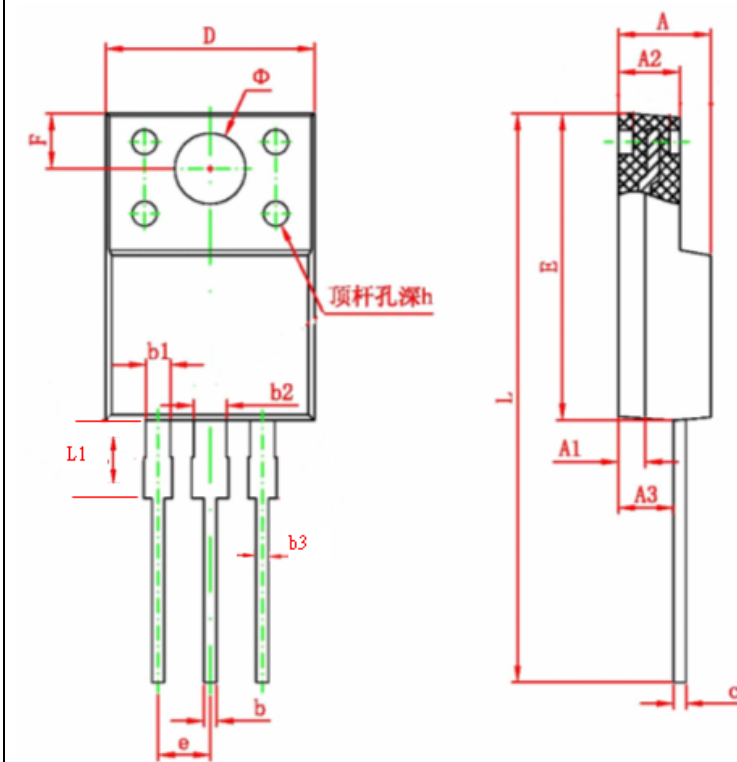

Fig.21 Reverse Recovery Time vs. Inverse Diode Forward Current



### PACKAGE DIMENSION

TO-220F



Symbol	Dimensions In Millimeters	
	Min.	Max
A	3.80	4.70
A1	1.3 REF.	
A2	2.20	3.20
A3	2.10	3.20
b	0.30	0.95
b1	1.00	1.75
b2	1.00	1.75
b3	0.50	0.80
c	0.30	0.90
D	9.90	10.40
E	14.60	16.20
e	2.54 TYP.	
F	3.00 REF.	
$\Phi$	3.50 REF.	
h	0.00	0.30
L	28.00	30.00
L1	3.20	3.55



## **IMPORTANT NOTICE**

Champion Microelectronic Corporation (CMC) reserves the right to make changes to its products or to discontinue any integrated circuit product or service without notice, and advises its customers to obtain the latest version of relevant information to verify, before placing orders, that the information being relied on is current.

A few applications using integrated circuit products may involve potential risks of death, personal injury, or severe property or environmental damage. CMC integrated circuit products are not designed, intended, authorized, or warranted to be suitable for use in life-support applications, devices or systems or other critical applications. Use of CMC products in such applications is understood to be fully at the risk of the customer. In order to minimize risks associated with the customer's applications, the customer should provide adequate design and operating safeguards.

### **HsinChu Headquarter**

5F, No. 11, Park Avenue II,  
Science-Based Industrial Park,  
HsinChu City, Taiwan

T E L : +886-3-567 9979  
F A X : +886-3-567 9909  
<http://www.champion-micro.com>

### **Sales & Marketing**

21F., No. 96, Sec. 1, Sintai 5th Rd., Sijhih City,  
Taipei County 22102,  
Taiwan R.O.C

T E L : +886-2-2696 3558  
F A X : +886-2-2696 3559