

FEATURES

- ◆ Fast switching for high efficiency
- ◆ Low noise
- ◆ $T_{rr} \sim 20ns$
- ◆ Ultra low reverse leakage current
- ◆ High voltage ultra faster diode PFC application
- ◆ High inrush current

MECHANICAL DATA

- ◆ Case : Molded plastic TO-220AC / TO-220FPAC
- ◆ Epoxy : UL94V-0 rate flame retardant
- ◆ Terminals : Solder able per MIL-STD-202 method 208
- ◆ 265°C Max. for 10 Seconds
- ◆ Maximum Mounting Torque 6 (5) Kg-cm(lbf-in)

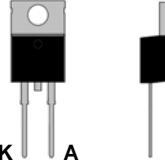

CMD15R06 (TO-220AC)

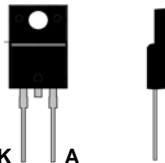

CMD15R06 (TO-220FPAC)

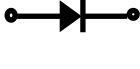

A K

Primary Characteristics

$I_{F(AV)}$	15A
V_{RM}	600 V
I_{RP}	6.5A
V_F	2.3V
I_R	10 μA
T_j	150 °C

ORDERING INFORMATION

Part Number	Temperature Range	Package
CMD15R06D*	-55°C to 150°C	TO-220AC
CMD15R06FP*	-55°C to 150°C	TO-220FPAC

*Note :

D* TO-220AC

FP*:TO-220FPAC

ABSOLUTE MAXIMUM RATINGS (Ta = 25°C)

Symbol	Parameter	Conditions	Limits	Unit
V _{RM}	Repetitive peak reverse voltage	Duty ≤ 0.5	600	V
V _R	Reverse voltage	Direct reverse voltage	600	V
I _F	Average current	60Hz half sin wave, resistive load	15	A
I _{FSM}	Non-repetitive forward surge current	60Hz half sin wave, one cycle, non-repetitive at T _j =25°C	150	A
T _J	Operating junction temperature		150	°C
T _{STG}	Storage temperature		-55~+150	°C

ELECTRICAL CHARACTERISTICS (Ta = 25°C)

Symbol	Parameter	Conditions		Min.	Typ.	Max.	Unit
V _F	Forward voltage	I _F =15A	T _j =25°C	1.6	2.3	2.8	V
			T _j =125°C		1.55		V
I _R	Reverse current	V _R =600V	T _j =25°C		0.03	10	uA
			T _j =125°C		10	200	uA
T _{rr}	Reverse recovery time	I _F =0.5A, I _R =1A, I _{RR} =0.25x I _R			20	30	nS
		I _F =15A, V _R =400V, DI _F /dt=-200A/us			30	50	nS
I _{RP}	Reverse recovery current	I _F =15A, V _R =400V, DI _F /dt=-200A/us	T _j =125°C		6.5		A
Q _{RR}	Reverse recovery charges				200		nC
T _{fr}	Forward recovery time	I _F =15A, DI _F /dt=-200A/us, V _{FR} =1.1x V _{Fmax}			150		nS
V _{FP}	Forward recovery voltage				5.5		V
R _{th} (j-a)	Thermal resistance	Junction to ambient	TO-220AC			2.0	°C/W
			TO-220FPAC			6.5	
R _{th} (j-c)	Thermal resistance	Junction to case	TO-220AC			1.2	°C/W
			TO-220FPAC			2.8	

APPLICATION CIRCUIT

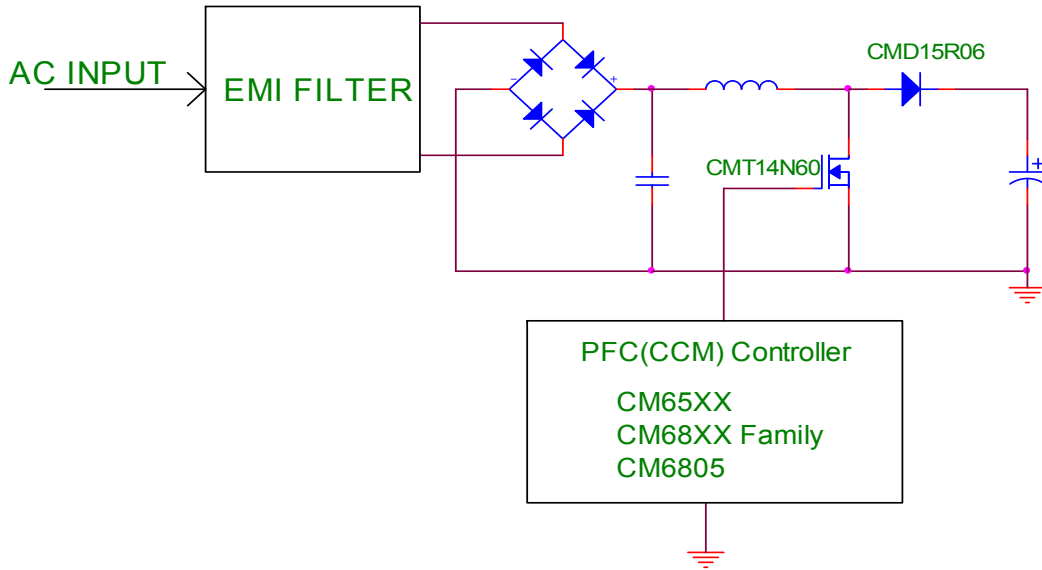

TYPICAL CHARACTERISTICS

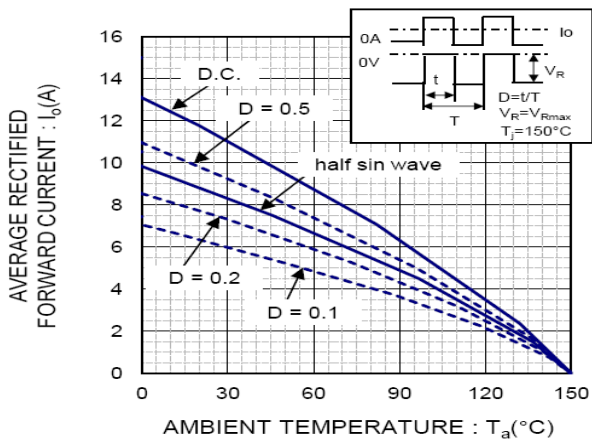

(TO-220FPAC)

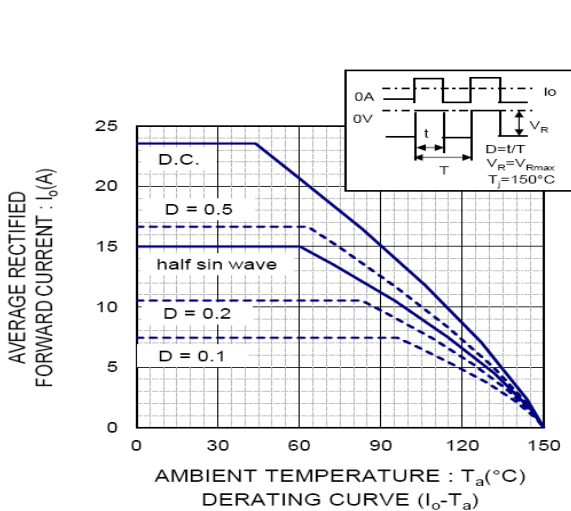
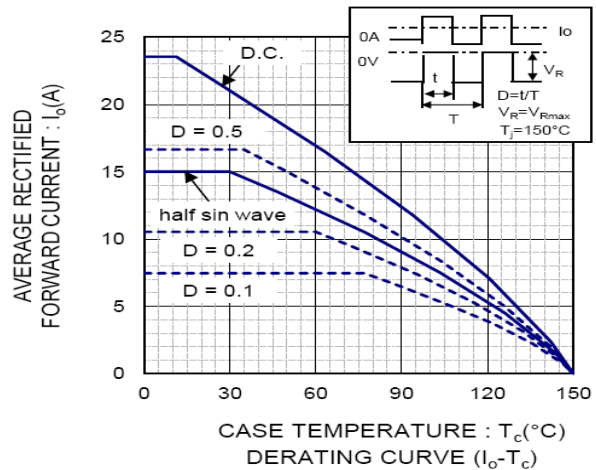

(TO-220AC)

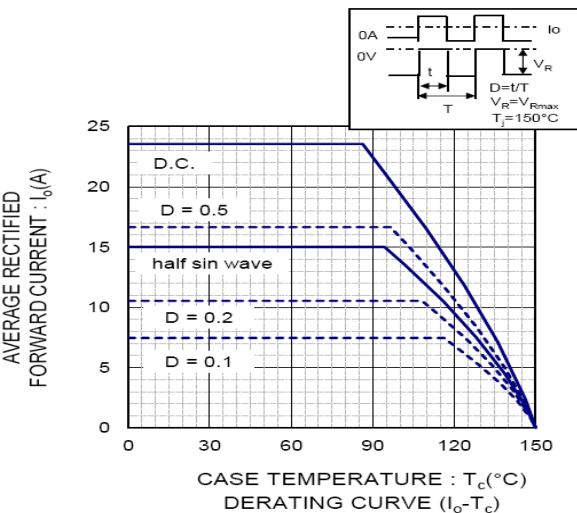

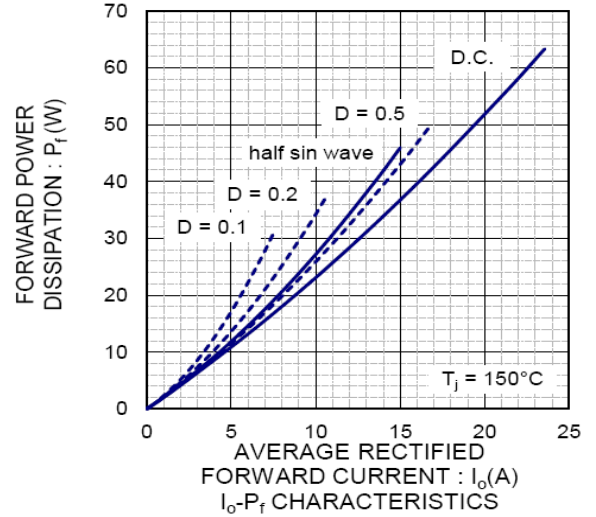
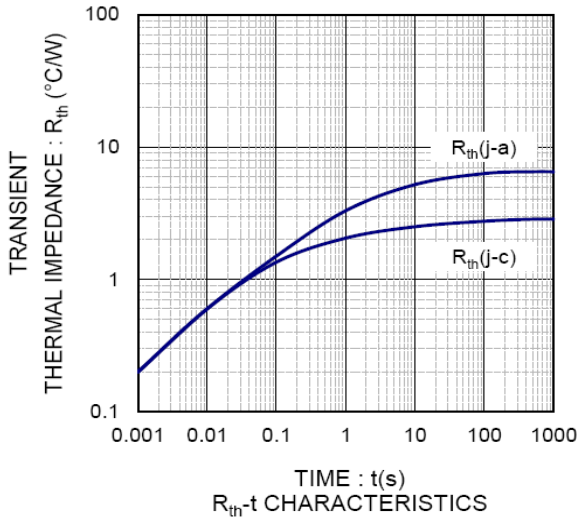

(TO-220FPAC)

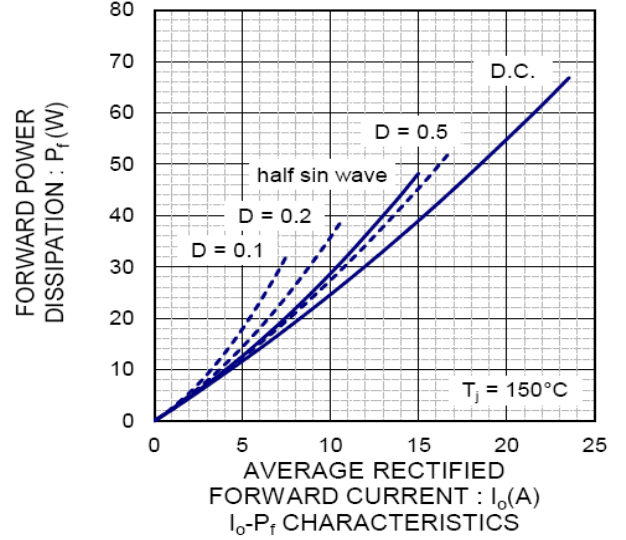
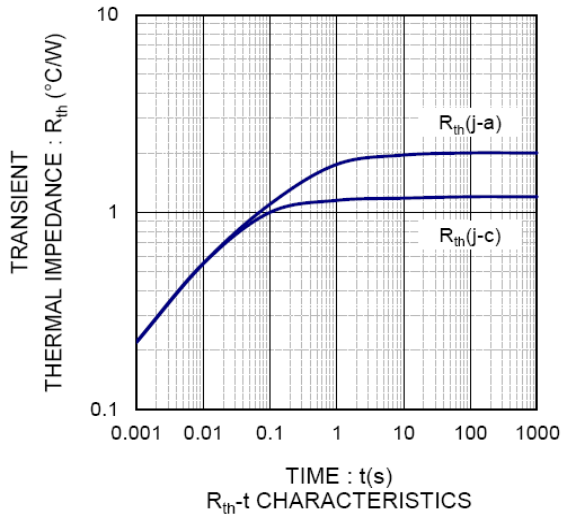

(TO-220AC)

TO-220FPAC & TO-220AC

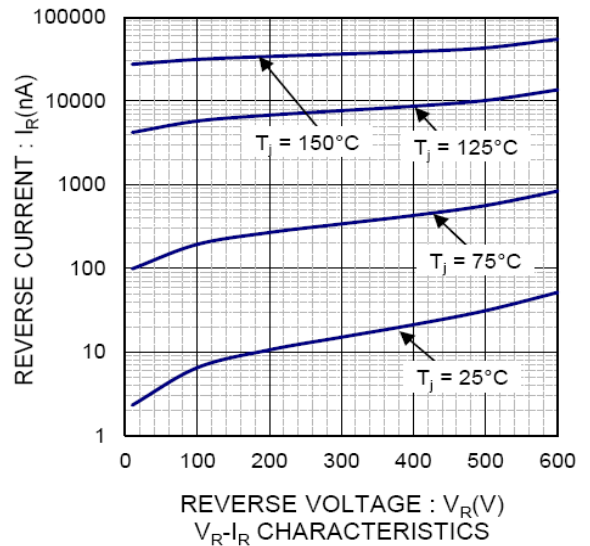
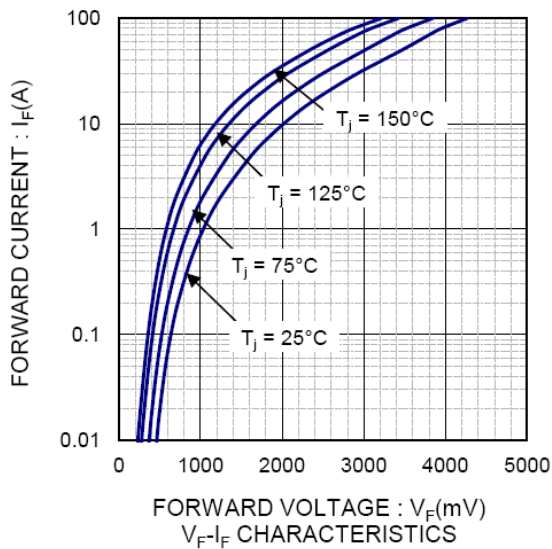

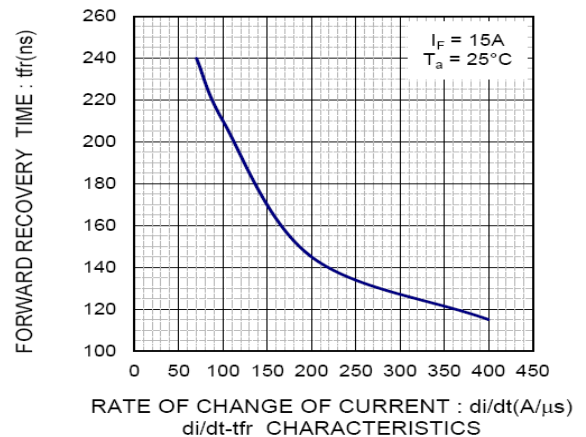
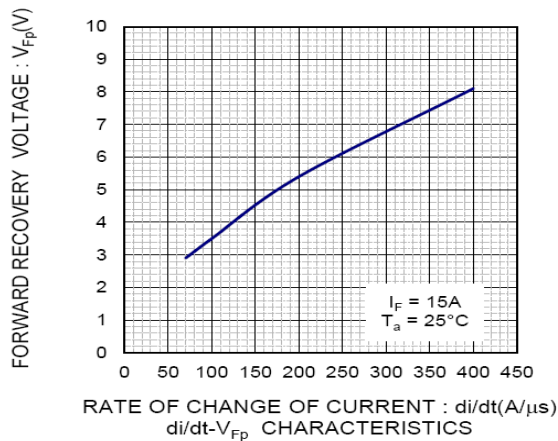
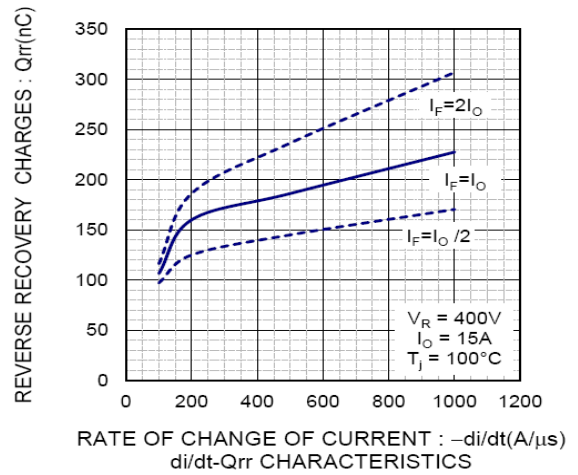
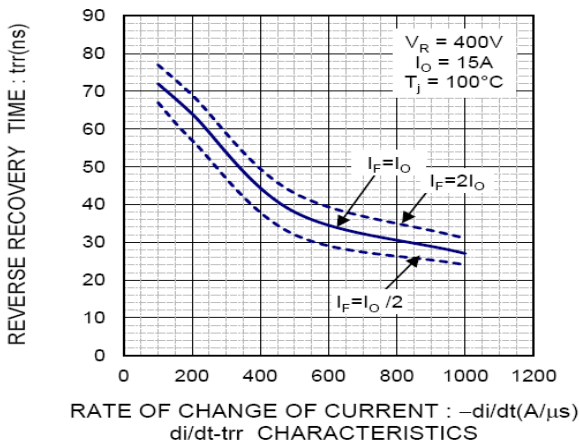
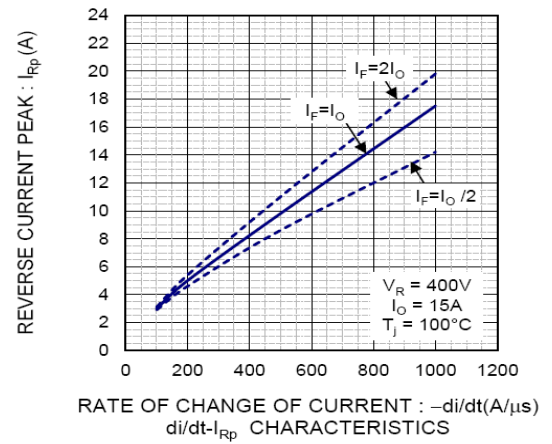
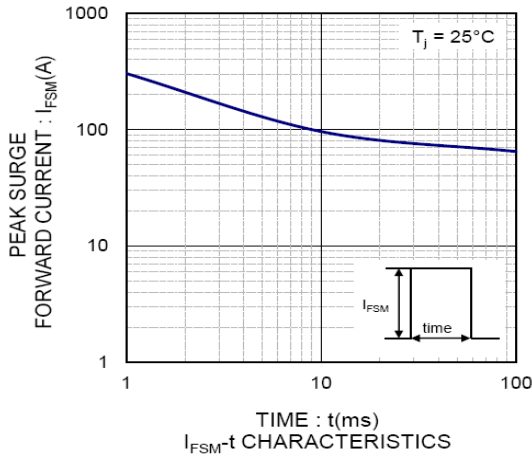
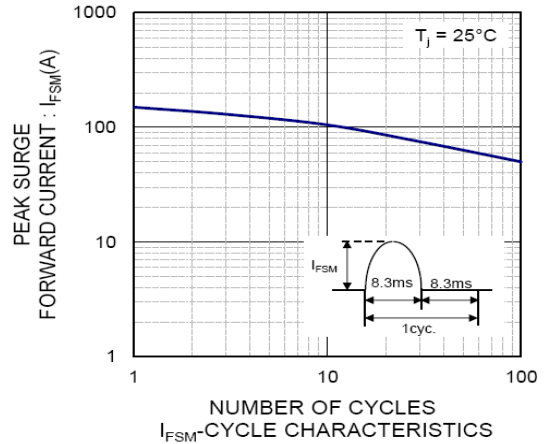
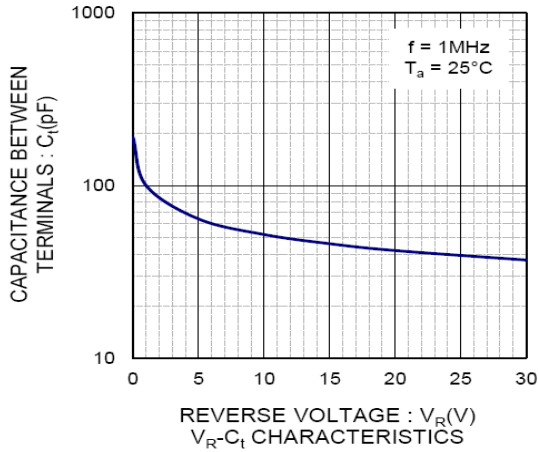

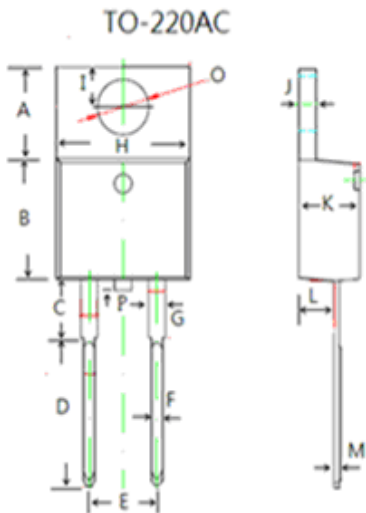
PACKAGE DIMENSION
TO-220AC

Dimension	Millimeters		Dimension	Millimeters	
	Min.	Max.		Min.	Max.
A	6.17	7.00	H	9.80	10.50
B	8.50	9.45	I	2.59	2.95
C	2.56	4.43	J	1.14	1.40
D	8.98	10.80	K	4.20	4.80
E	4.60	5.60	L	2.20	2.82
F	0.70	0.91	M	0.28	0.60
G	1.17	1.55	O	3.56	3.94
			P		1.00

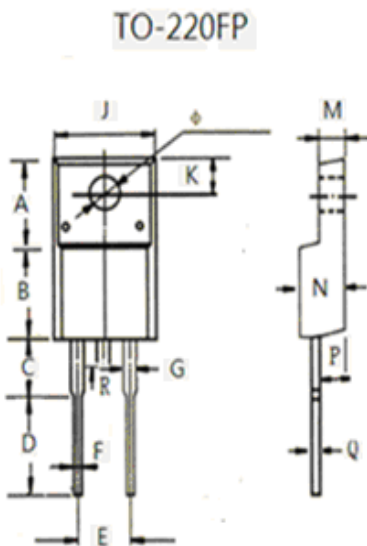
TO-220FPAC

Dimension	Millimeters		Dimension	Millimeters	
	Min.	Max.		Min.	Max.
A	5.84	6.98	J	9.90	10.50
B	8.05	9.97	K	2.50	3.80
C	2.79	4.10	M	2.34	3.30
D	8.94	10.65	N	4.20	4.90
E	4.60	5.60	O	2.08	3.56
F	0.30	0.90	P	2.45	2.92
G	1.08	1.48	Q	0.35	0.80
			R		1.00

IMPORTANT NOTICE

Champion Microelectronic Corporation (CMC) reserves the right to make changes to its products or to discontinue any integrated circuit product or service without notice, and advises its customers to obtain the latest version of relevant information to verify, before placing orders, that the information being relied on is current.

A few applications using integrated circuit products may involve potential risks of death, personal injury, or severe property or environmental damage. CMC integrated circuit products are not designed, intended, authorized, or warranted to be suitable for use in life-support applications, devices or systems or other critical applications. Use of CMC products in such applications is understood to be fully at the risk of the customer. In order to minimize risks associated with the customer's applications, the customer should provide adequate design and operating safeguards.

HsinChu Headquarter

5F, No. 11, Park Avenue II,
Science-Based Industrial Park,
HsinChu City, Taiwan

T E L : +886-3-567 9979
F A X : +886-3-567 9909
<http://www.champion-micro.com>

Sales & Marketing

21F., No. 96, Sec. 1, Sintai 5th Rd., Sijhih City,
Taipei County 22102,
Taiwan R.O.C

T E L : +886-2-2696 3558
F A X : +886-2-2696 3559