



QR806/QR806F/QR806D

SUPERFAST RECOVERY RECTIFIERS

VOLTAGE 600 Volt **CURRENT** 8 Ampere

FEATURES

- Planar structure with EPI wafer
- Ultrafast recovery time, low V_f and soft recovery
- For PFC (DCM/CCM) operation
- Low leakage current
- Plastic package has Underwriters Laboratory Flammability Classification 94V-O Flame Retardant Epoxy Molding Compound
- Exceeds environmental standards of MIL-S-19500/228
- Lead free in compliance with EU RoHS 2011/65/EU directive

MECHANICAL DATA

- Case: TO-220AC, ITO-220AC, TO-263 package
- Terminals: Lead solderable per MIL-STD-750, Method 2026
- TO-220AC Weight: 0.065 ounces, 1.859 grams
- ITO-220AC Weight: 0.055 ounces, 1.5615 grams
- TO-263 Weight: 0.051 ounces, 1.46 grams

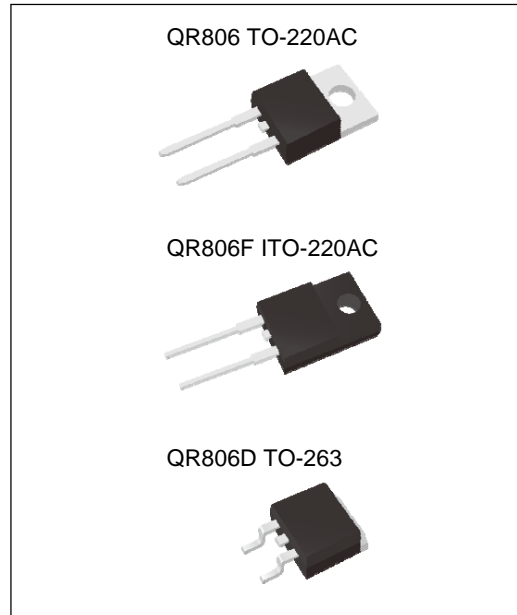

MAXIMUM RATINGS($T_A=25^{\circ}\text{C}$ unless otherwise noted)

PARAMETER	SYMBOL	VALUE	UNIT
Maximum recurrent peak reverse voltage	V_{RRM}	600	V
Maximum rms voltage	V_{RMS}	420	V
Maximum dc blocking voltage	V_R	600	V
Maximum average forward rectified current	$I_{F(AV)}$	8	A
Peak forward surge current 8.3ms single half sine-wave superimposed on rated load	I_{FSM}	120	A
Typical thermal resistance	$R_{\theta JC}$	TO-220AC(Note 1)	2
		ITO-220AC(Note 1)	5.5
		TO-263 (Note 1)	2
Operating junction temperature range	T_J	-55 to + 150	$^{\circ}\text{C}$
Storage temperature range	T_{STG}	-55 to + 150	$^{\circ}\text{C}$

NOTE:

1. Device mounted on a infinite heatsink , then measured the center of the marking side.



QR806/QR806F/QR806D

ELECTRICAL CHARACTERISTICS(T_A=25°C unless otherwise noted)

PARAMETER	SYMBOL	TEST CONDITIONS	MIN.	TYP.	MAX.	UNIT
Breakdown voltage	V _{BR}	I _R =100μA	600	-	-	V
Instantaneous forward voltage	V _F	I _F =1A I _F =5A I _F =8A T _J =25°C	-	0.98 1.23 1.33	- - 1.65	V
		I _F =1A I _F =5A I _F =8A T _J =125°C	-	0.73 1.01 1.13	- - 1.35	V
Reverse leakage current	I _R	V _R =600V T _J =25°C T _J =125°C	- -	- -	3 100	μA
Reverse recovery time	T _{RR}	I _F =0.5A I _R =1A I _{RR} =0.25A T _J =25°C	-	-	45	ns
		I _F =1A V _R =30V di/dt=100A/μs T _J =25°C	-	-	35	ns
		I _F =8A V _R =400V di/dt=200A/μs T _J =25°C	-	70	-	ns
Peak recovery current	I _{RRM}	I _F =8A V _R =400V di/dt=200A/μs T _J =25°C	-	3.5	-	A
Reverse recovery charge	Q _{RR}	I _F =8A V _R =400V di/dt=200A/μs T _J =25°C	-	150	-	nC



QR806/QR806F/QR806D

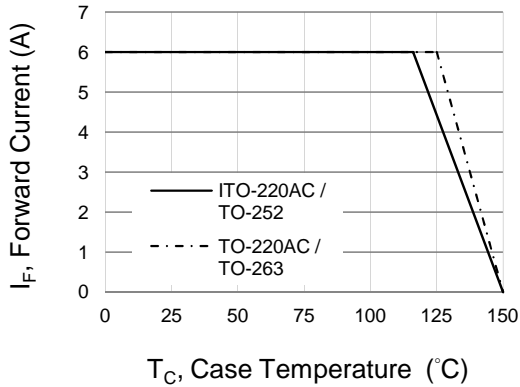

Fig.1 Forward Current Derating Curve

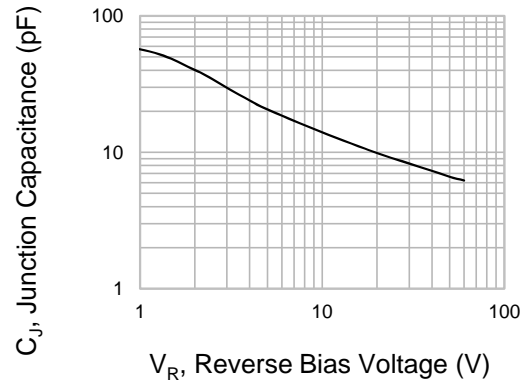

Fig.2 Typical Junction Capacitance

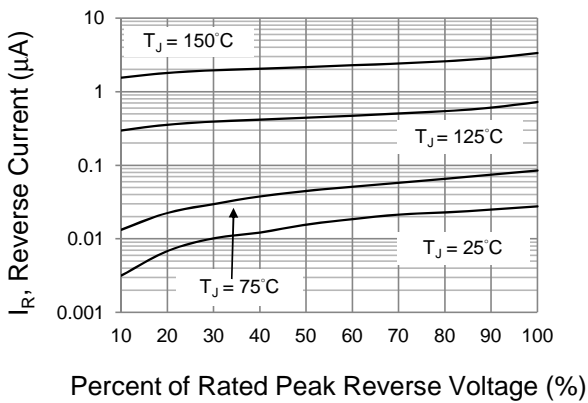

Fig.3 Typical Reverse Characteristics

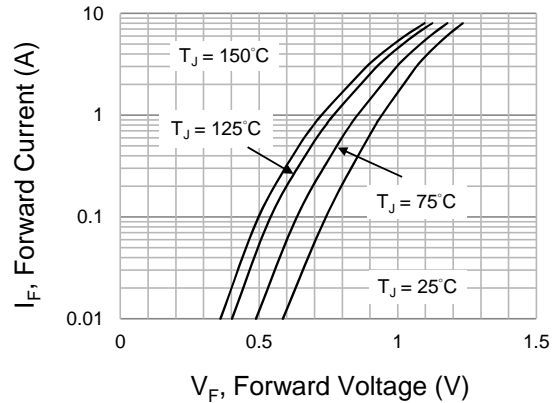

Fig.4 Typical Forward Characteristics

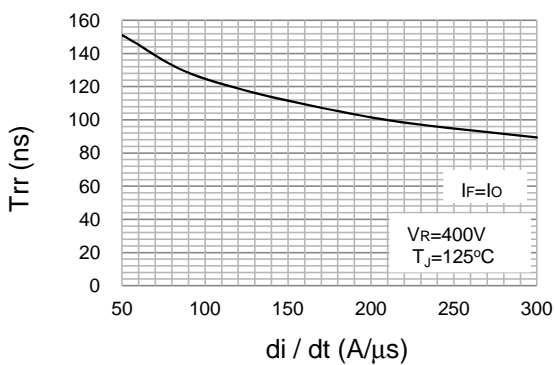

Fig.5 Typical Reverse recovery time versus di/dt

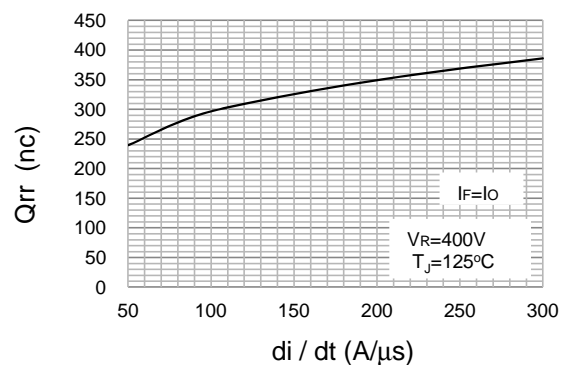

Fig.6 Typical Reverse recovery charges versus di/dt



QR806/QR806F/QR806D

TO-220AC

Unit : inch(mm)

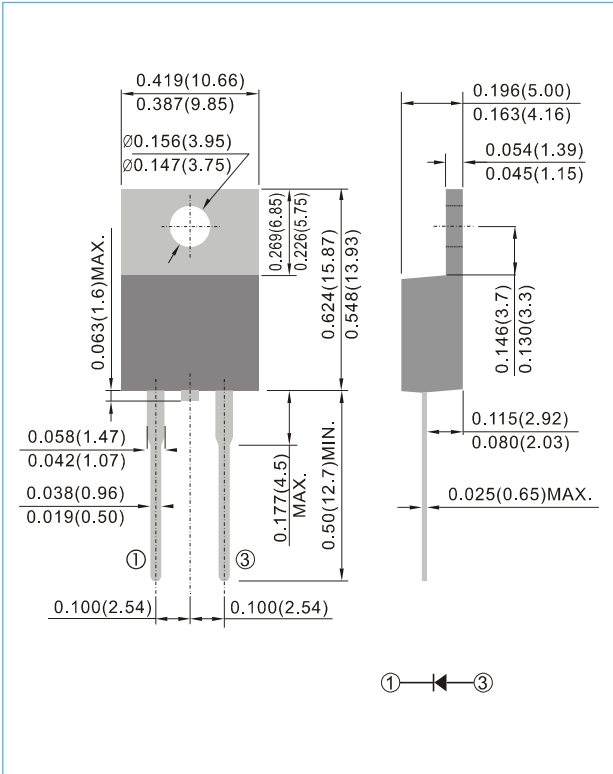

ITO-220AC

Unit : inch(mm)

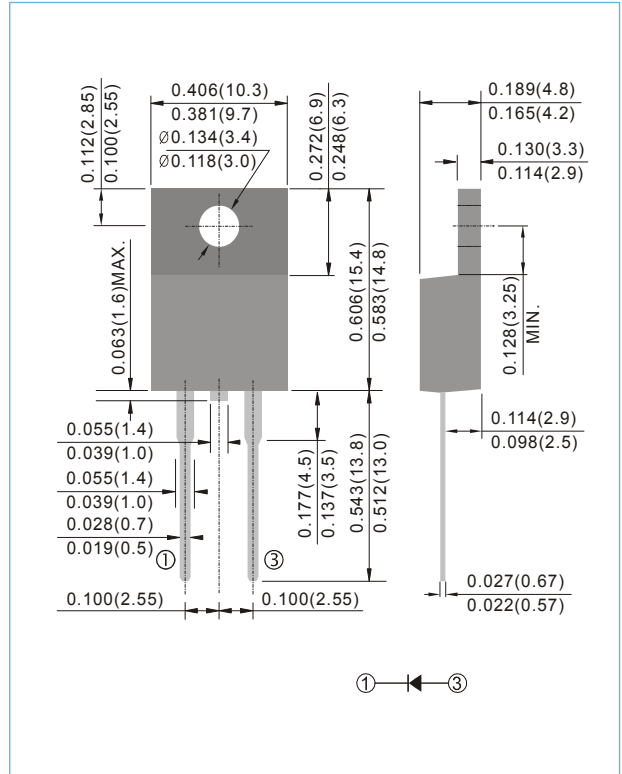

TO-263 / D²PAK

Unit : inch(mm)

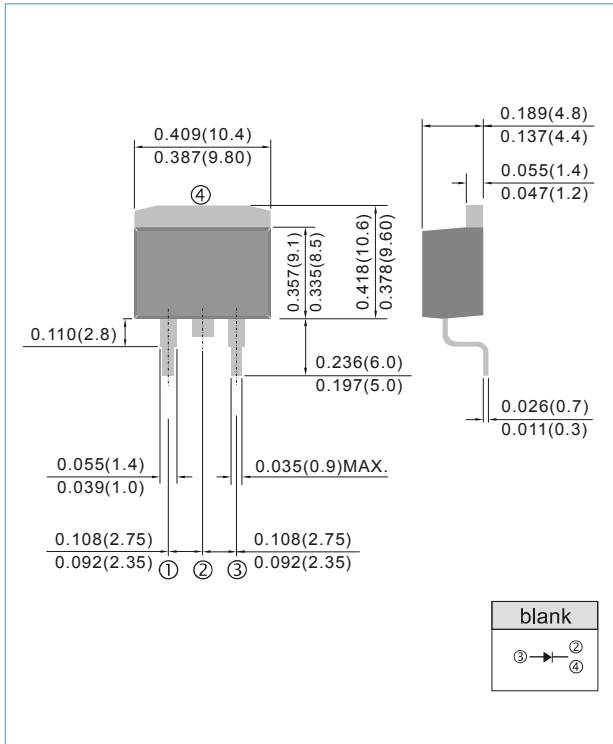



QR806/QR806F/QR806D

MOUNTING PAD LAYOUT

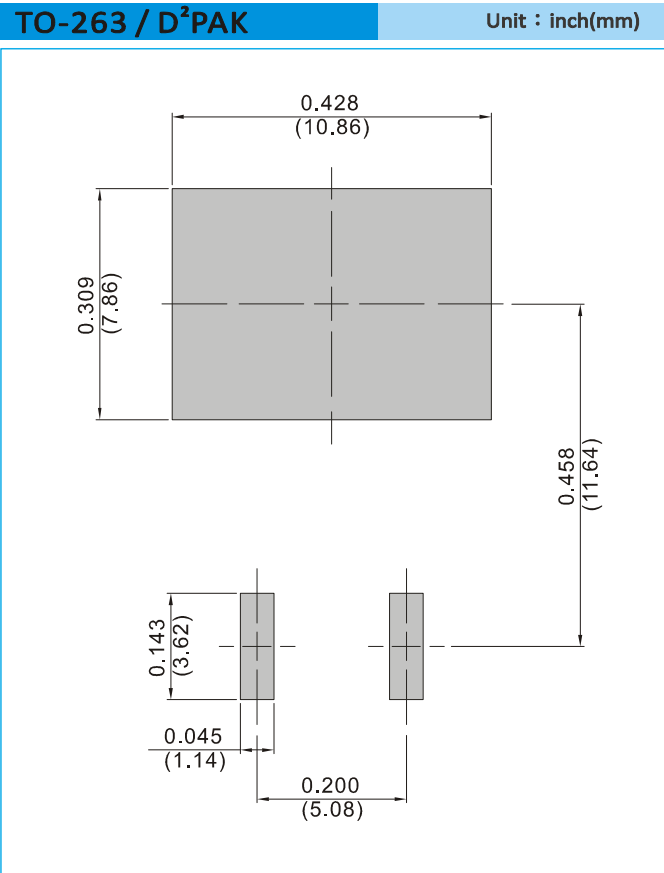

ORDER INFORMATION

- Packing information
T/R - 0.8K per 13" plastic Reel



QR806/QR806F/QR806D

Part No_packing code_Version

QR806_T0_00001
 QR806_T0_10001
 QR806F_T0_00001
 QR806F_T0_10001
 QR806D_R2_00001
 QR806D_R2_10001

For example :

RB500V-40_R2_00001



Packing Code XX				Version Code XXXXX		
Packing type	1 st Code	Packing size code	2 nd Code	HF or RoHS	1 st Code	2 nd ~5 th Code
Tape and Ammunition Box (T/B)	A	N/A	0	HF	0	serial number
Tape and Reel (T/R)	R	7"	1	RoHS	1	serial number
Bulk Packing (B/P)	B	13"	2			
Tube Packing (T/P)	T	26mm	X			
Tape and Reel (Right Oriented) (TRR)	S	52mm	Y			
Tape and Reel (Left Oriented) (TRL)	L	PANASERT T/B CATHODE UP (PBCU)	U			
FORMING	F	PANASERT T/B CATHODE DOWN (PBCD)	D			



QR806/QR806F/QR806D

Disclaimer

- Reproducing and modifying information of the document is prohibited without permission from Panjit International Inc..
- Panjit International Inc. reserves the rights to make changes of the content herein the document anytime without notification. Please refer to our website for the latest document.
- Panjit International Inc. disclaims any and all liability arising out of the application or use of any product including damages incidentally and consequentially occurred.
- Panjit International Inc. does not assume any and all implied warranties, including warranties of fitness for particular purpose, non-infringement and merchantability.
- Applications shown on the herein document are examples of standard use and operation. Customers are responsible in comprehending the suitable use in particular applications. Panjit International Inc. makes no representation or warranty that such applications will be suitable for the specified use without further testing or modification.
- The products shown herein are not designed and authorized for equipments requiring high level of reliability or relating to human life and for any applications concerning life-saving or life-sustaining, such as medical instruments, transportation equipment, aerospace machinery et cetera. Customers using or selling these products for use in such applications do so at their own risk and agree to fully indemnify Panjit International Inc. for any damages resulting from such improper use or sale.
- Since Panjit uses lot number as the tracking base, please provide the lot number for tracking when complaining.